



Instruction Manual

Counting Hoops Basketball Stand



VTech understands that a child's needs and abilities change as they grow and with that in mind we develop our toys to teach and entertain at just the right level...

Electronic Learning Computers

Cool, aspirational and inspiring computers for curriculum related learning

Pre-School

Interactive toys to develop their imagination and encourage language development

vtech Baby

Toys that will stimulate their interest in different textures, sounds and colours

I am...

...responding to colours, sounds and textures

...understanding cause and effect

...learning to touch, reach, grasp, sit-up, crawl and toddle

I want...

...to get ready for school by starting to learn the alphabet and counting

...my learning to be as fun, easy and exciting as can be

...to show my creativity with drawing and music so my whole brain develops

I need...

...challenging activities that can keep pace with my growing mind

...intelligent technology that adapts to my level of learning

...National Curriculum based content to support what I'm learning at school

Birth-36 months



3-6 years



4-10 years



To learn more about this and other VTech® products, visit www.vtech.co.uk

INTRODUCTION

The **Counting Hoops Basketball Stand** can be adjusted from heights between 1075mm/3'6" and 1400mm/4'7", and offers 3 different activities to grow with your child. Go solo or gather some friends to practise your skills! It's a slam dunk!

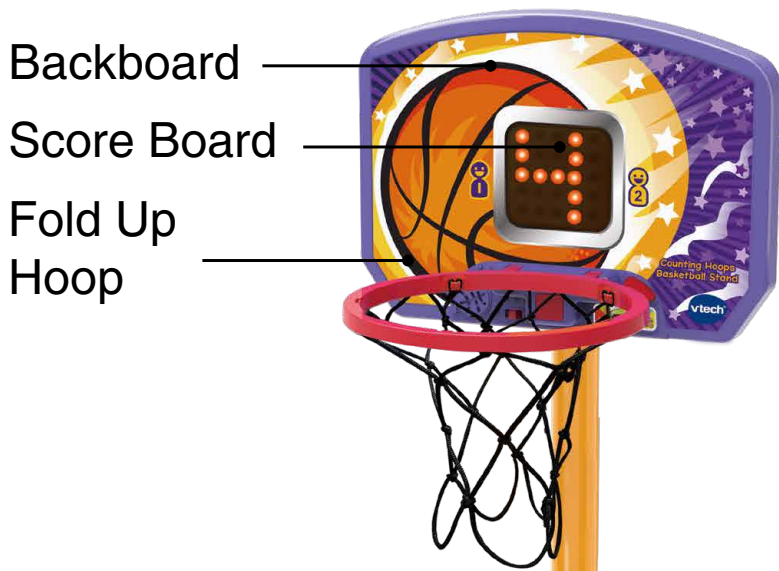

YOU WILL NEED



OR



INCLUDED IN THIS PACKAGE



x 1



x 1



x 1



x 1



x 1



x 1



x 1



x 1



x 1



x 1

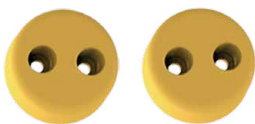

x 2



x 1



x 11

A



x 3

B

WARNING

All packing materials such as tape, plastic sheets, packaging locks, removable tags, cable ties, cords and packaging screws are not part of this toy and should be discarded for your child's safety.

NOTE

Please save this Instruction Manual as it contains important information.

⚠ CAUTION:

This package contains small screws. Adult assembly required. For your child's safety, do not let your child play with the toy until it is fully assembled.

INSTRUCTIONS

WARNING:

Adult assembly required for battery installation.
Keep batteries out of reach of children.

Battery Removal and Installation

1. Make sure the unit is turned OFF.
2. Locate the battery cover on the back of the unit. Use a screwdriver to loosen the screw and then open the battery cover.
3. If used batteries are present, remove these batteries from the unit by pulling up on one end of each battery.
4. Install 3 new AA (AM-3/LR6) batteries following the diagram inside the battery box. (For best performance, alkaline batteries or fully charged Ni-MH rechargeable batteries are recommended).
5. Replace the battery cover and tighten the screw to secure.

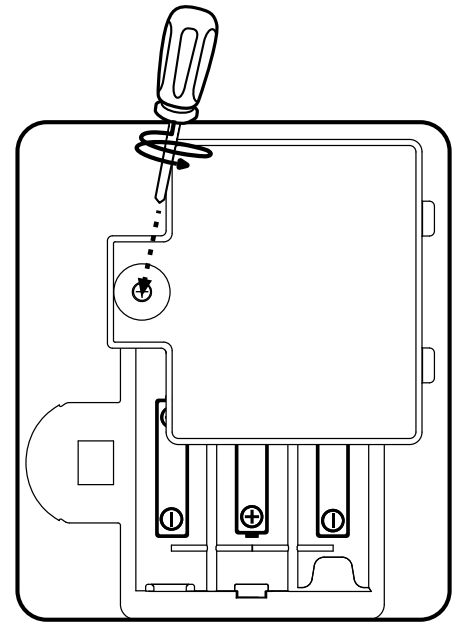

IMPORTANT: BATTERY INFORMATION

- Insert batteries with the correct polarity (+ and -).
- Do not mix old and new batteries.
- Do not mix alkaline, standard (carbon-zinc) or rechargeable batteries.
- Only batteries of the same or equivalent type as recommended are to be used.

- Do not short-circuit the supply terminals.
- Remove batteries during long periods of non-use.
- Remove exhausted batteries from the toy.
- Dispose of batteries safely. Do not dispose of batteries in fire.

RECHARGEABLE BATTERIES:

- Remove rechargeable batteries (if removable) from toy before charging.
- Rechargeable batteries are only to be charged under adult supervision.
- Do not charge non-rechargeable batteries.

Disposal of batteries and product



The crossed-out wheellie bin symbols on products and batteries, or on their respective packaging, indicates they must not be disposed of in domestic waste as they contain substances that can be damaging to the environment and human health.

The chemical symbols Hg, Cd or Pb, where marked, indicate that the battery contains more than the specified value of mercury (Hg), cadmium (Cd) or lead (Pb) set out in the Batteries and Accumulators Regulation.



The solid bar indicates that the product was placed on the market after 13th August, 2005.

 Please dispose of your product and batteries responsibly.

In the UK, give this toy a second life by disposing of it at a small electricals collection point* so all of its materials can be recycled.

Learn more at:

www.vtech.co.uk/recycle

www.vtech.com.au/sustainability

* Visit www.recyclenow.com to see a list of collection points near you.

ASSEMBLY INSTRUCTIONS

With the **Counting Hoops Basketball Stand**, safety comes first. Adult assembly required. For your child's safety, do not let them play with this toy until it is fully assembled.

NOTE: To prevent the **Counting Hoops Basketball Stand** from falling over and causing injury, the base must be filled fully with sand or water. **DO NOT** let your child play with this toy until the base has been fully filled.

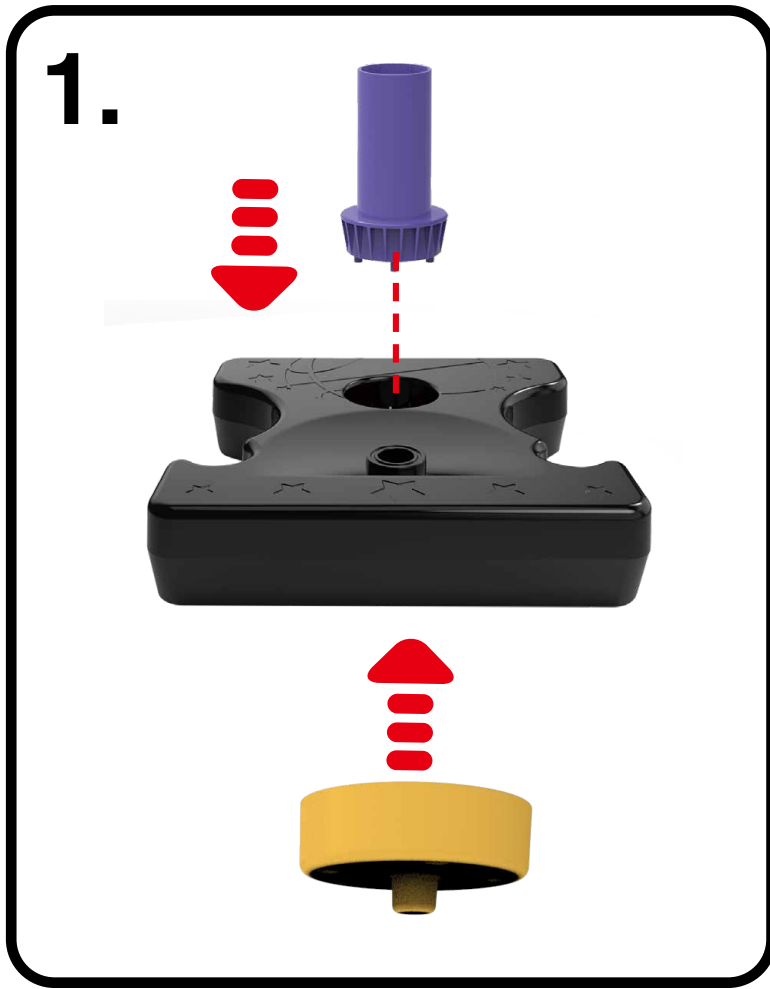

A X4

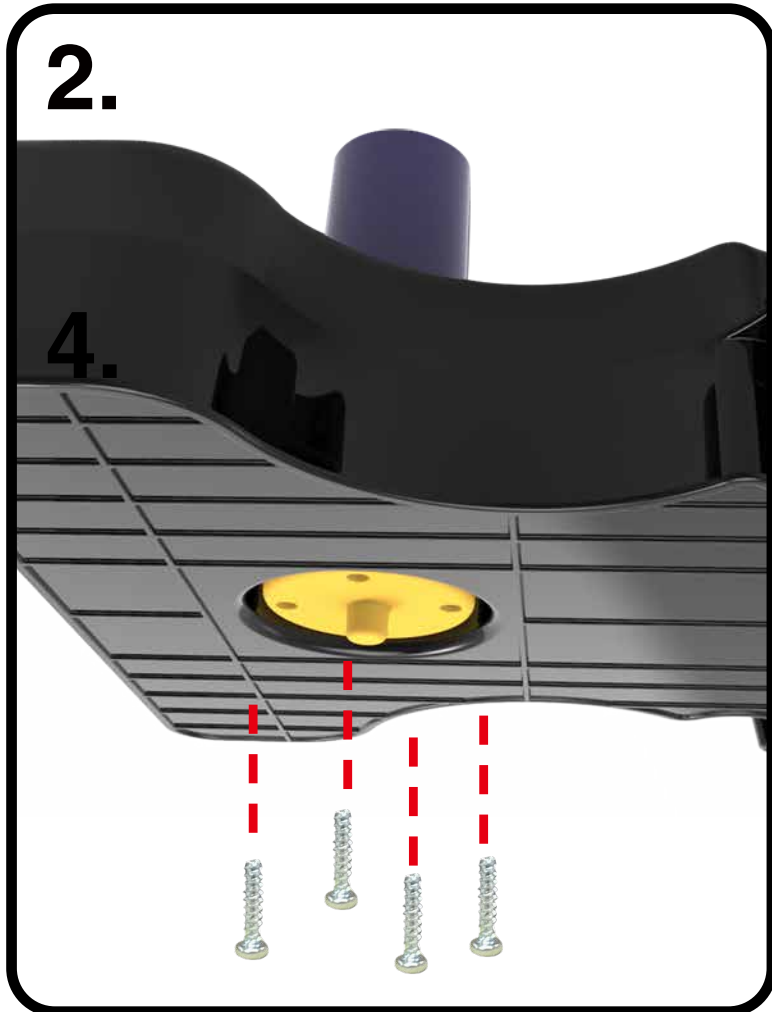

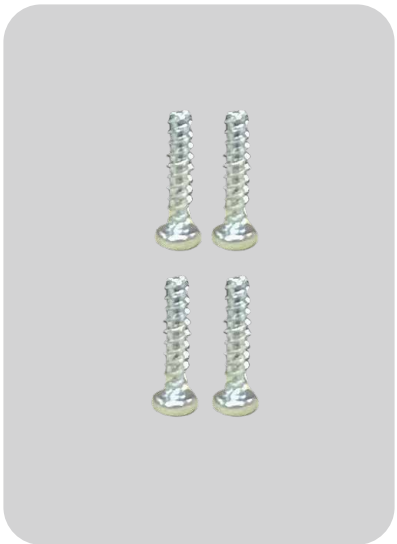
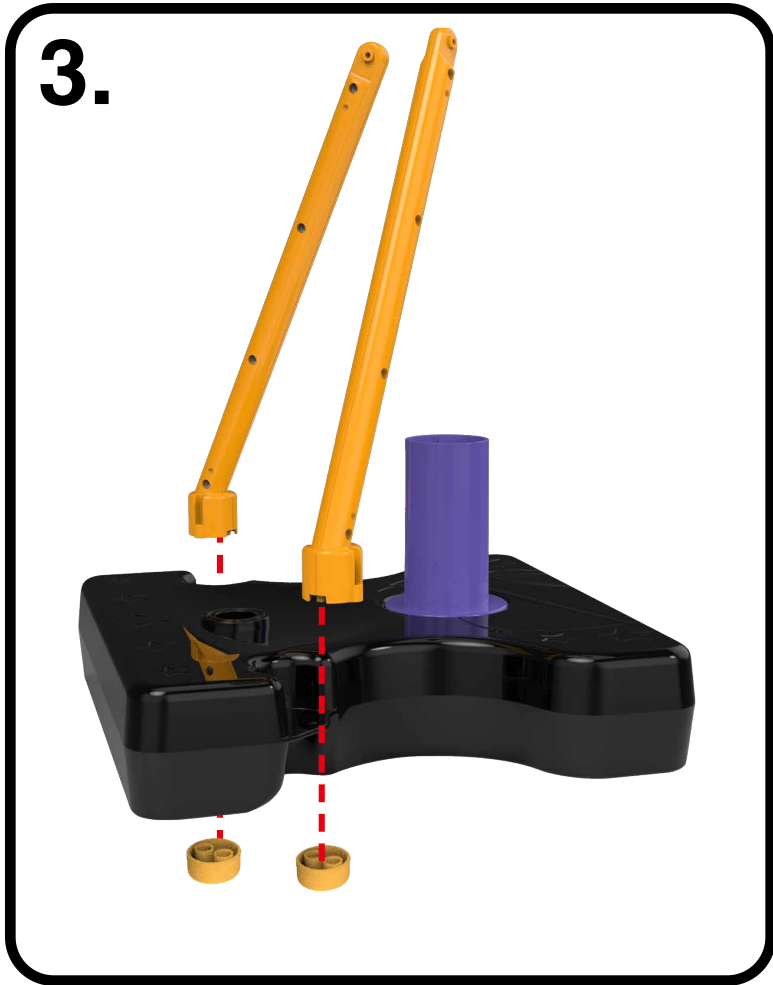

A X4

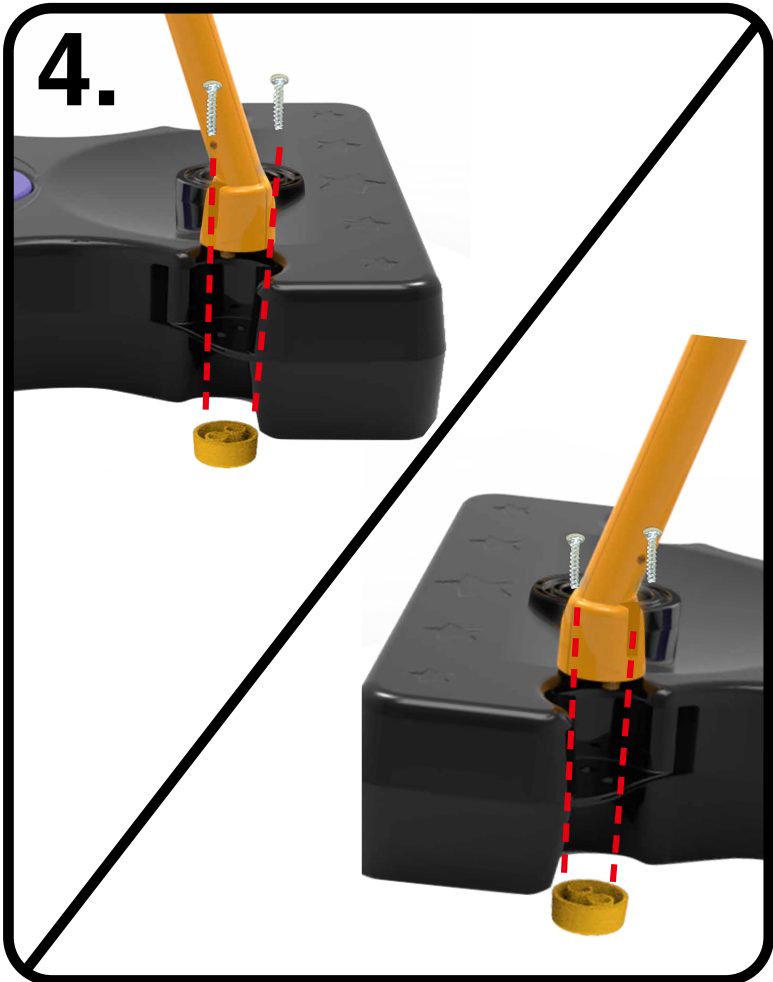

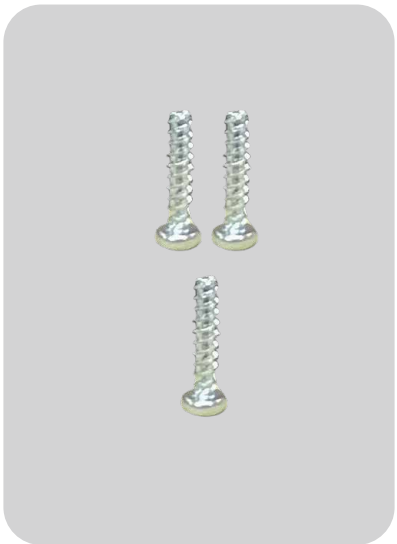
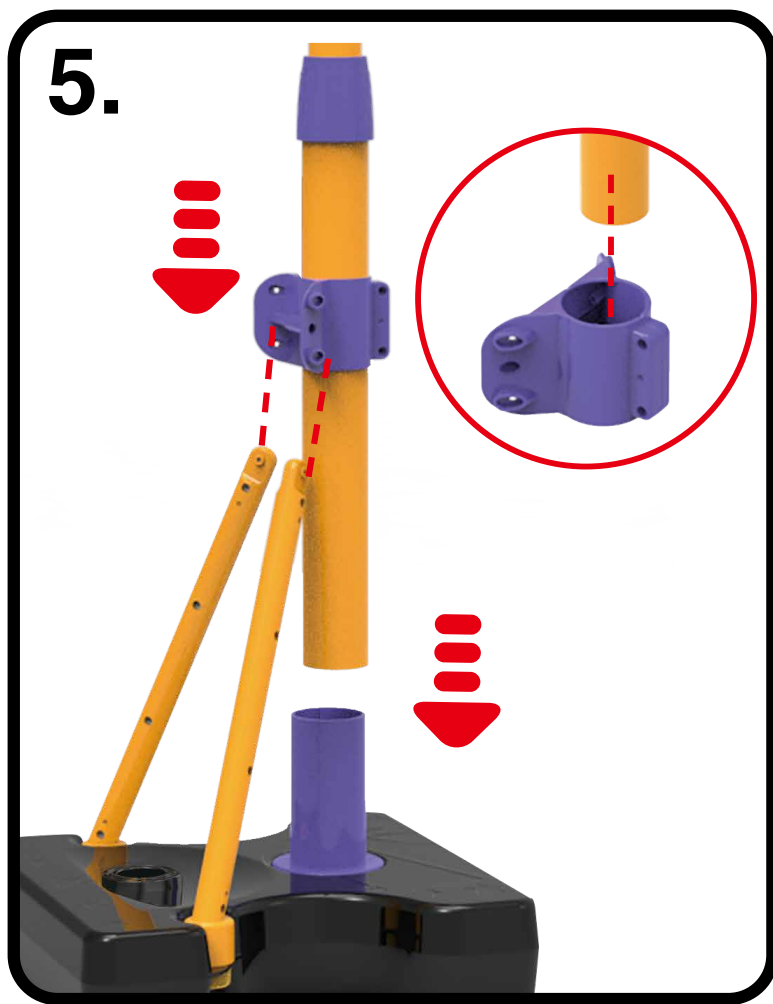
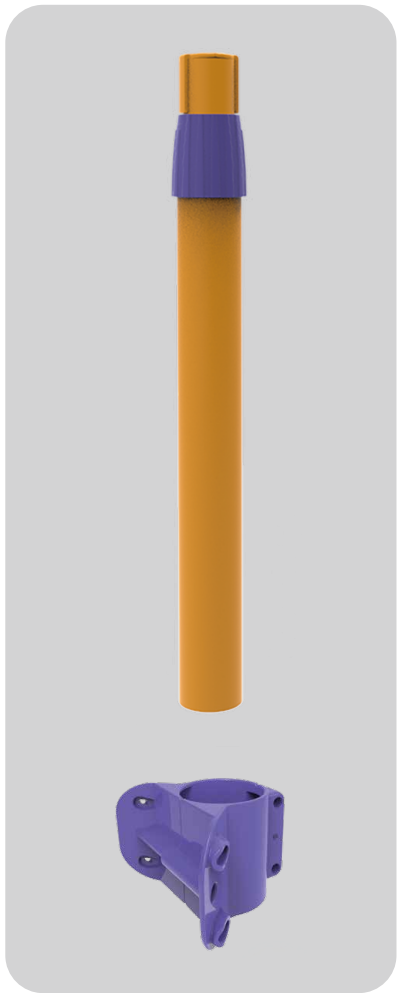

A X3

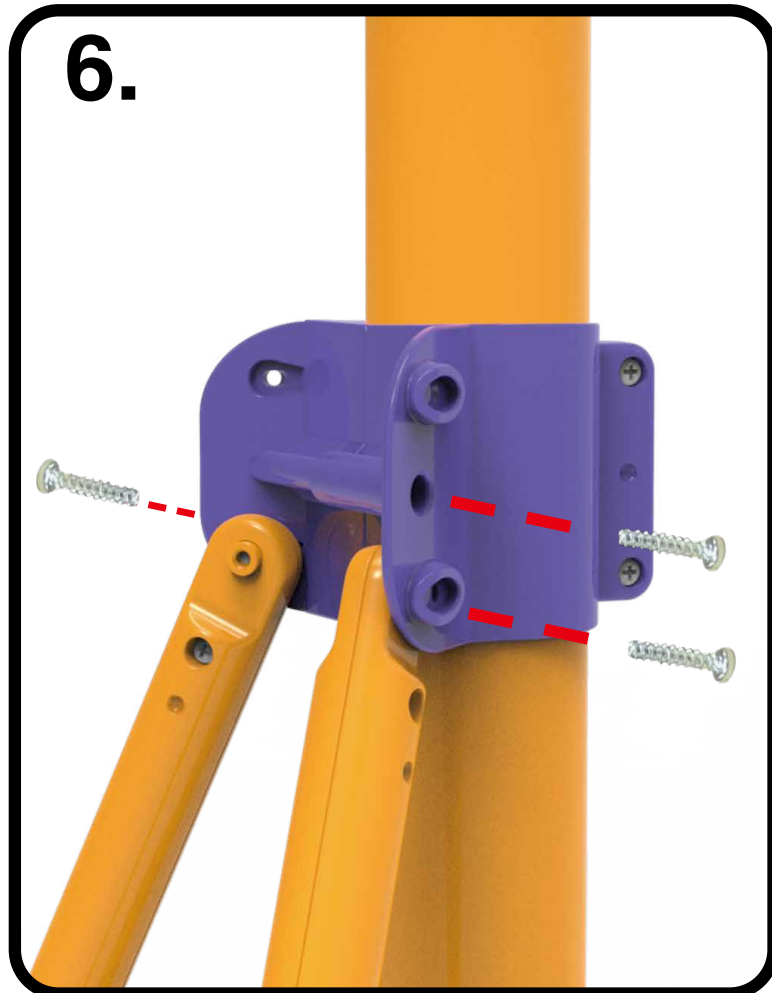

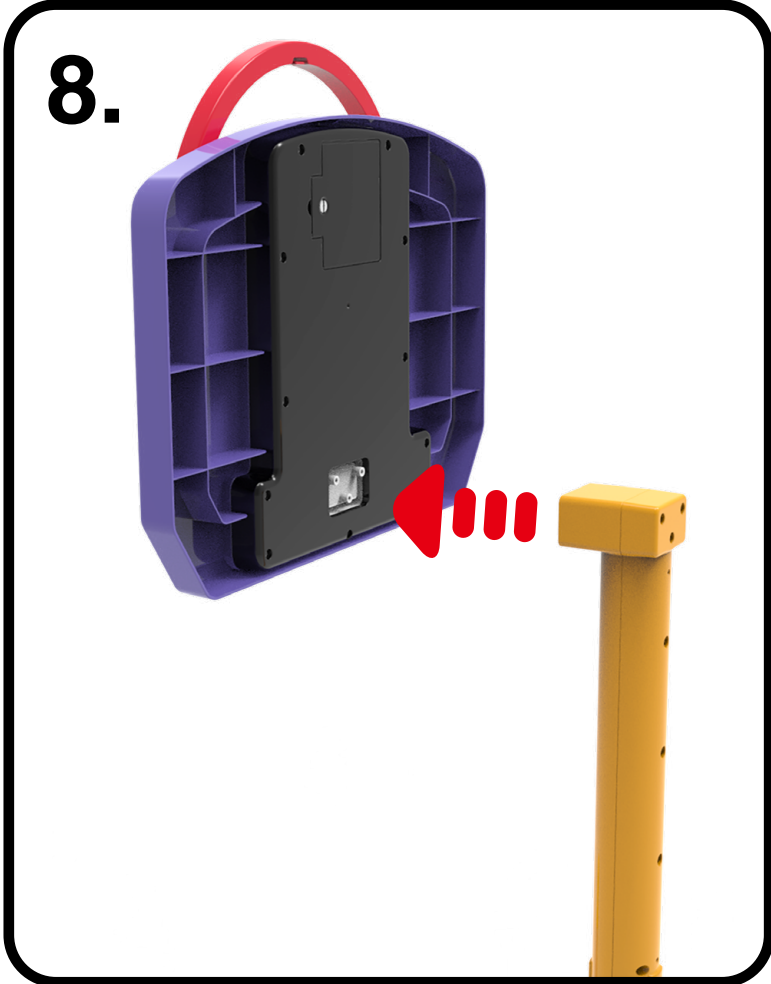
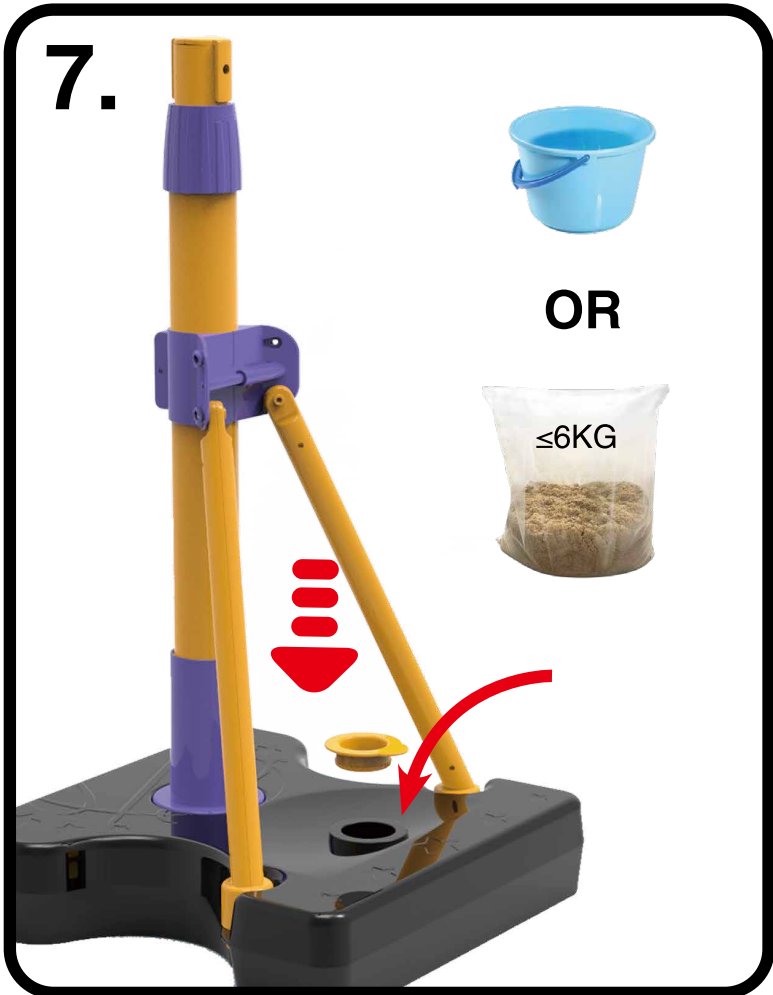



B X3

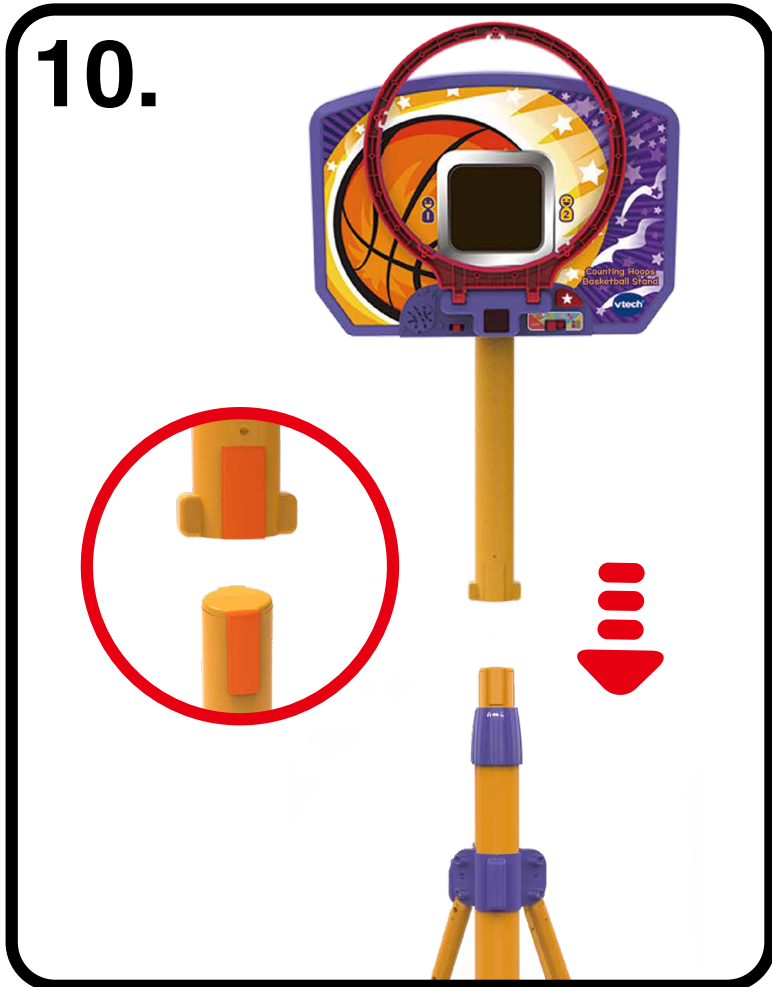
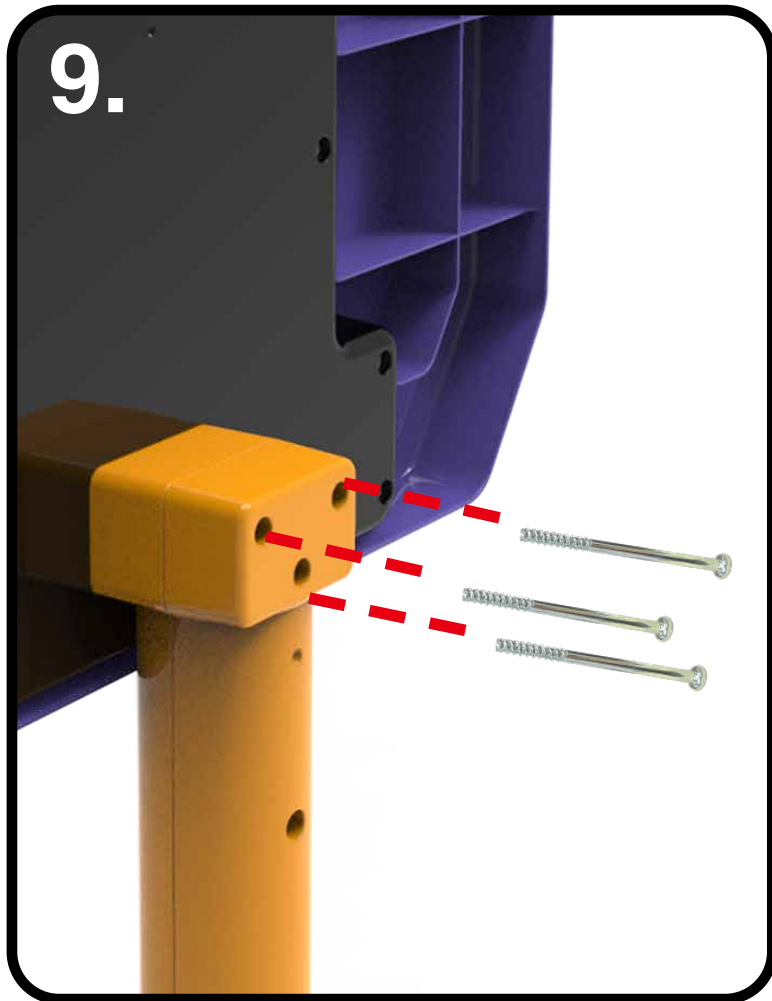

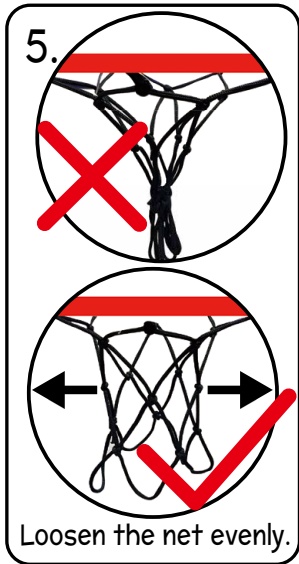
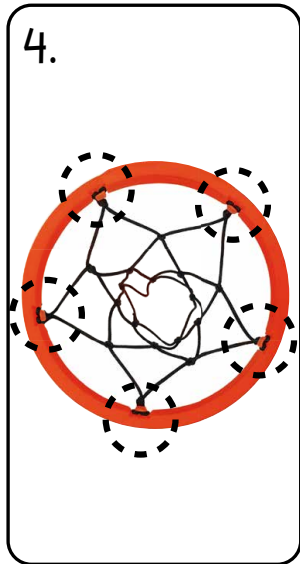
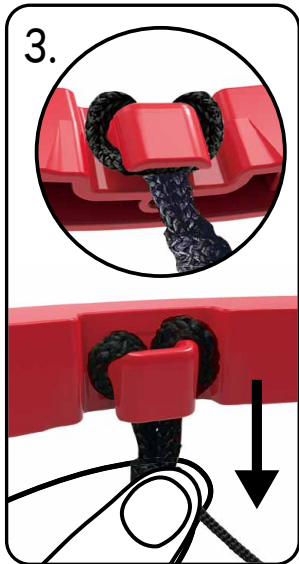
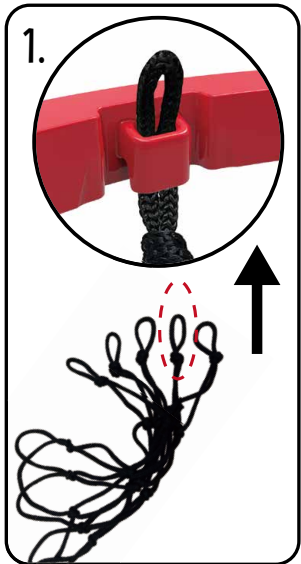

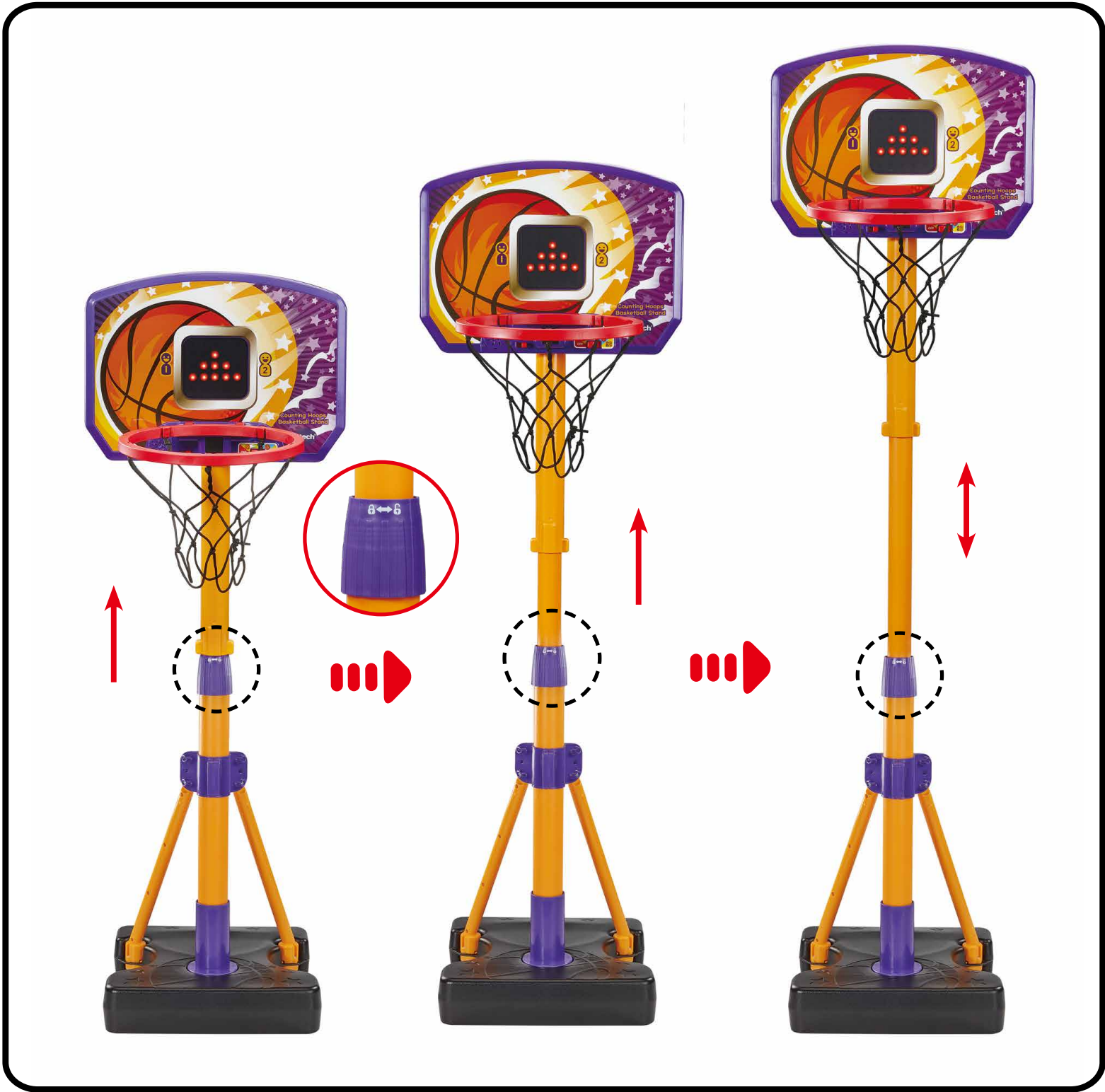

Note:
Fold up the hoop when not in use to save space.

PRODUCT FEATURES

1. On/Off/Mode Switch

Slide the **On/Off/Mode Switch** to choose an activity or turn the unit off. Choose from three activities.



2. Mute/Volume Switch

To adjust the volume, slide the **Mute/Volume Switch** right to Low or High, or slide the switch left to turn off the sound.

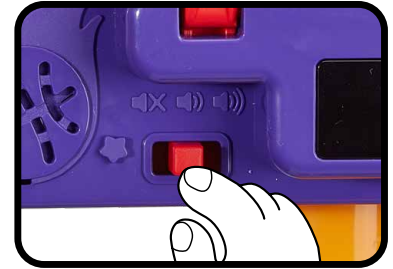

3. Select Button

Use the **Select Button** to choose a theme for **Copy Cat**, a level for **Aim For The Shape**, or choose between 1 or 2 player mode for **Buzzer Beater Challenge**.



4. Automatic Shut-Off

To preserve battery life, the **Counting Hoops Basketball Stand** will automatically shut off after several minutes without input. The unit can be turned on again by sliding the **On/Off/Mode Switch**.

TO BEGIN PLAY

Slide the **On/Off/Mode Switch** to the right and select a game to play.

ACTIVITIES

1. Copy Cat

Slide the **On/Off/Mode Switch** to  to enter this activity.

Press the **Select Button** to choose a theme: Busy Bugs, Monster Mania, Alien Arcade or Free Play. Follow the instructions to play.

2. Aim For The Shape

Slide the **On/Off/Mode Switch** to  to enter this activity. Try to score a basket when you see the requested shape, number or object shown on the screen. Press the **Select Button** to choose from 3 levels of play. You will automatically level up when you complete a challenge.

3. Buzzer Beater Challenge

Slide the **On/Off/Mode Switch** to  to enter this activity. Press the **Select Button** to choose between 1 or 2 players. See how many baskets you can make in the time given! (60 seconds per player)

CARE & MAINTENANCE

1. Keep the unit clean by wiping it with a slightly damp cloth.
2. Keep the unit out of direct sunlight and away from any direct heat source.
3. Remove the batteries when the unit is not in use for an extended period of time.
4. Do not drop the unit on hard surfaces and do not expose the unit to moisture or water.

TROUBLESHOOTING

If for some reason the unit stops working or malfunctions, please follow these steps:

1. Please turn the unit **OFF**.
2. Interrupt the power supply by removing the batteries.
3. Let the unit stand for a few minutes, then replace the batteries.
4. Turn the unit **ON**. The unit should now be ready to play with again.
5. If the product still does not work, install a brand new set of batteries.

If the problem persists, please contact our Consumer Services Department and a service representative will be happy to help you.

CONSUMER SERVICES

Creating and developing **VTech**[®] products is accompanied by a responsibility that we at **VTech**[®] take very seriously. We make every effort to ensure the accuracy of the information, which forms the value of our products. However, errors sometimes can occur. It is important for you to know that we stand behind our products and encourage you to call our Consumer Services

Department with any problems and/or suggestions that you might have. A service representative will be happy to help you.

UK Customers:

Phone: 0330 678 0149 (from UK) or +44 330 678 0149 (outside UK)

Website: www.vtech.co.uk/support

Australian Customers:

Phone: 1800 862 155

Website: support.vtech.com.au

NZ Customers:

Phone: 0800 400 785

Website: support.vtech.com.au

Product Warranty/ Consumer Guarantees

UK Customers:

Read our complete warranty policy online at vtech.co.uk/warranty.

Australian Customers:

VTECH ELECTRONICS (AUSTRALIA) PTY LIMITED – CONSUMER GUARANTEES

Under the Australian Consumer Law, a number of consumer guarantees apply to goods and services supplied by VTech Electronics (Australia) Pty Limited. Please refer to vtech.com.au/consumerguarantees for further information.

**Visit our website for more
information about our products,
downloads, resources and more.**

www.vtech.co.uk
www.vtech.com.au

